

Hydrodynamics of Ship Propellers

Contents

- Introduction 5
- Testing of Propellers 6
- Calculation Methods for Propellers 8
 - Series Propellers 8
 - Lifting Line Designed Propellers 9
 - Lifting Surface Designed Propellers 11
 - Surface Panel Designed Propellers 12
- Hydrodynamic Design of CP Propellers 13
 - Design Conditions 13
 - Main Parameters 14
 - Tank Test Results 15
 - Design Objectives 15
 - Blade Design 16
- Model Test and Full Scale Results 20
 - Cases 20
 - Twin Screw 3990 GT Cruise Vessel 20
 - Single Screw 6000 DWT Chemical Tanker 20
 - Single Screw 16000 DWT Tanker 21
 - Single Screw 5100 DWT Chemical Tanker 21
 - Twin Screw Supply Vessel AHTS 22
- Conclusion 22
- References 23

Designing propellers for ships has always been a challenge due to the complexity of all the factors involved. These factors are not only related to the propeller itself but also to the hull and the propulsion system which must work together as integrated systems in an optimised and reliable way.

Introduction

A century ago, Sir Charles Parson designed the world's first steam turbine powered vessel named "Turbinia". The vessel incorporated a number of innovative design features and broke the speed record at that time. At "Turbinia's" first sea-trials in 1894, it showed a disappointing ship's speed of only 19.5 knots despite trying different propeller designs on the single screw vessel.

After intensive research Parson realised that the speed problem arose from the formation of vapour bubbles around the propeller blades. This observation was later to be called cavitation and today it still plays a significant role in designing propellers.

To study the phenomenon of cavitation, Parson built the world's first cavitation tunnel in which a number of small model propellers were tested. Based on his experiments the "Turbinia" was redesigned by distributing the power between three shafts and using much improved blade shapes. He finally succeeded in setting the speed record with a staggering 34 knots, thereby outperforming even the Royal Navy's torpedo gun boats which could achieve a speed of 30 knots - a speed considered to be impressive at that time.



When faced with the problem of cavitation, Parson built his own primitive cavitation tunnel and probably without knowing it, he contributed to the understanding of propellers by inventing one of the most powerful tools for analysing of cavitation.

Over the years a number of tools have been added to the toolbox - most of which are of the analytic type - but the most important one is probably the development achieved by the appearance of increasingly faster computers over the last two decades.

The design tools for propellers have evolved in two different directions, one being the empirical/testing and the other the analytical/calculating. Through the last century they have supported each other well and both have contributed to the understanding of the propeller and the conditions in which it works.

The 'Turbinia' steaming at sea on one of her runs. The vessel was finally modified to achieve the impressive 34 knots.



Testing of Propellers

Today the testing of not only the propeller but also the hull takes place at well established and recognised hydrodynamic institutions around the world.

The testing is performed by towing and propelling 6 to 10 m long hull models through a 200 to 300 m long model tank. In two separate tests the resistance and the power needed at different ship speeds are measured. In the initial stage of the testing, the propeller used is selected among the large number of existing propellers, which the institute has in its possession. This propeller is usually designated a stock propeller. Later the actual propeller designed for the vessel can be manufactured in model scale and fitted on the ship model to verify its performance efficiency.

An important part of the testing, seen from a propeller designer's point of view, is the measurement of the wake field, which will give the inflow velocities to the propeller at any radial and circumferential position. The wake



field is obtained by substituting the propeller with a pitot probe, rotated around the propeller shaft. The probe measures the pressure which can later be converted into the three velocity components (axial, tangential and radial).

A hull model being towed in the model tank for determination of resistance and power.

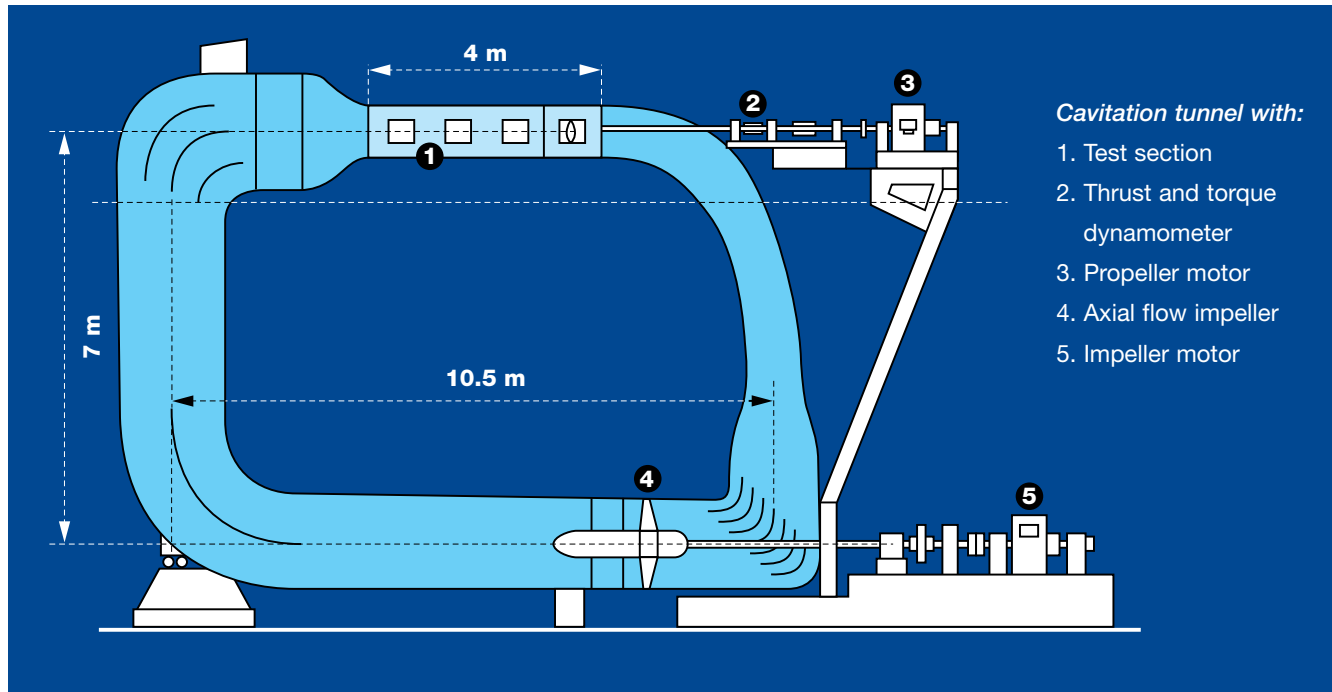

When observing a propeller blade rotating behind a ship's hull, one will discover that the inflow velocities and pressure will change depending on the blade's angular position. Especially for single screw full body ships the twelve o'clock position can cause the pressure to drop under the saturation pressure eventually leading to cavitation.

One aspect that cannot be tested in the long model tank is the cavitation behaviour of the propeller. This is due to difference in pressures between model and full scale and the subsequent cavitation test is consequently performed in a cavitation tunnel, where the pressure in model scale can be adjusted to match the full scale one.

The propeller model is placed in the tunnel at the upper measurement section and driven by its own motor. The water in the closed loop tunnel is circulated by an impeller situated in the lower part of the tunnel.

Only at very few institutions is it possible to place the whole ship model in the cavitation tunnel and as a consequence the correct wake field needs to be modelled by placing a dummy model upstream of the propeller. It requires considerable skill from the personnel at the institutions to achieve the same wake field in the cavitation tunnel as was measured in the model tank. Therefore careful measurements must be carried out to verify that this is the case.

Today, cavitation tests are not carried out for the same reasons as in the day of Parson, who discovered a pronounced drop in propeller efficiency. Parson's initial propeller was probably what today would be characterized as a super cavitating propeller, fully surrounded by air bubbles, which reduces the efficiency drastically and creates loud noise and vibrations in the aft body of the ship.

Propellers for merchant ships of today are much more limited in their extent of cavitation on the blades resulting in only a marginal drop in efficiency, but the noise and vibration problem still remains.



Cavitation will be present on most propellers of today's merchant vessels especially when operating at maximum power. Compared to the earlier hull designs the ones of today are much more full bodied (high block coefficient) which unfortunately will cause that the wake field experienced by the propeller blade through one rotation gets much more uneven. This makes it almost impossible to design a propeller for modern full body ships without any cavitation, unless a pronounced drop in efficiency is accepted.

The true nature of cavitation has still not been fully understood, although much more insight has been gained over the last decades.

Cavitation is associated with the generation of air bubbles which are formed at the propeller blades where the pressure gets below the saturation pressure of the water. The formation of bubbles is in itself not of much concern, but when the bubbles sooner or later enter into a high pres-

A cavitating propeller.

sure region they will implode. This will not only result in high levels of noise and vibrations in the aft part of the vessel but the cavitation can also be of an erosive nature if the implosion takes place at the propeller or rudder surface.

The objectives of testing propellers in a cavitation tunnel is twofold. On one hand, the test should reveal that no harmful cavitation erosion exists on the propeller blade and on the other, that the pressure impulses measured at prescribed locations on the hull surface do not exceed a limit being acceptable to the type of vessel tested.

The pressure impulse level is recorded by pressure transducers mounted flush with the hull surface above the propeller and the value measured in kPa (kilo Pascal) is used as a criterion for the performance level.

Calculation Methods for Propellers

Since the invention of the screw propeller there has been a strong desire to be able to analyse and in particular to design propeller blades by applying hydrodynamic theories.

Series Propellers

The first serious attempt was made by designing a series of model propellers with different blade numbers, blade area ratios, pitch distributions etc and subsequently testing all different propellers in an open water condition - ie uniform inflow without the influence from the hull.

One significant example of series propellers is the Wageningen propeller series [1] which constitute a comprehensive set of data for the propeller designer. To facilitate the daily use, charts have been worked out from which a propeller can be selected based on the design and the operating data it is supposed to match. Today, propeller series such as Wageningen are still used in the project stage to optimise the global parameters such as diameter, blade area ratio, number of blades etc with respect to efficiency.

One drawback of the series propeller is its cavitation performance when operating in the wake field behind the actual ship. Once a propeller has been selected the pitch and camber distribution is fixed - parameters which are of the utmost importance for its cavitation performance.

Many vibration problems on vessels, which were designed before introduction of the computer designed wake adapted propellers, can be ascribed to series propellers being applied without sufficient insight into their cavitation behaviour when operating in the uneven wake field behind the ship in question.

Lifting Line Designed Propellers

In 1952, H W Lerbs [2] introduced a new method for calculating propellers named “lifting line”. Lerbs proposed to substitute the propeller blade with a so-called lifting line along which the radial distribution of lift is calculated under the influence of a number of trailing vortices.

This was a new step forward in which the radial distribution of circulation (resembling lift or thrust) could be specified in order to obtain the optimum efficiency. An important difference from early days was the possibility to include the influence of the wake field. But the most consequential difference was the option to select profile section at each radius which could not only result in the optimum circulation/lift but which could also be selected with a combination of camber and pitch to achieve optimum cavitation performance.

With the publication of the NACA airfoil sections of the 16. and 66. series at almost the same time, a powerful tool was emerging, which for the first time could give the propeller designer a possibility to design a propeller with respect to cavitation aspects.

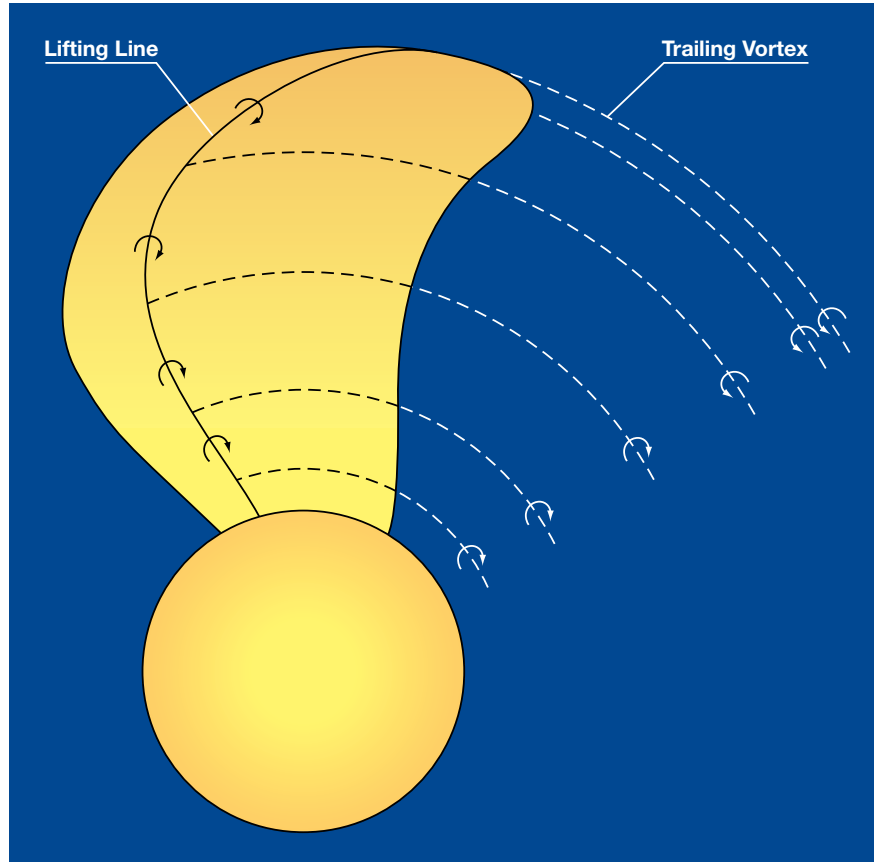

Principle of the “lifting line” calculation model.

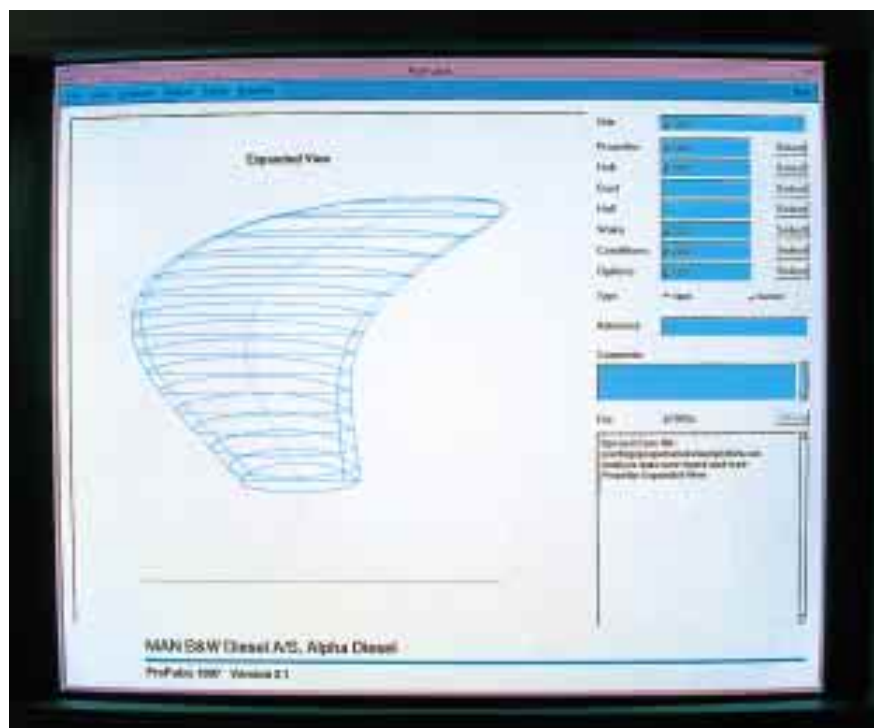

MAN B&W modified NACA airfoil sections of the 16. series.

Evaluation of the cavitation was facilitated by the work of T Brockett [3] who, for the above NACA airfoil sections, calculated a series of charts from which the onset of cavitation could be determined.

Only the onset of cavitation could be calculated - not the degree of the chord-wise extension over the blade surface. As already mentioned a certain level of cavitation must regrettably be accepted on most merchant vessels in order not to compromise the efficiency too much. To overcome this obstacle, a method was devised by MAN B&W [4] to calculate the chord-wise distribution of lift by using a conformal mapping technique. As a result the cavitation could be a truly integrated part of the design process for the first time.

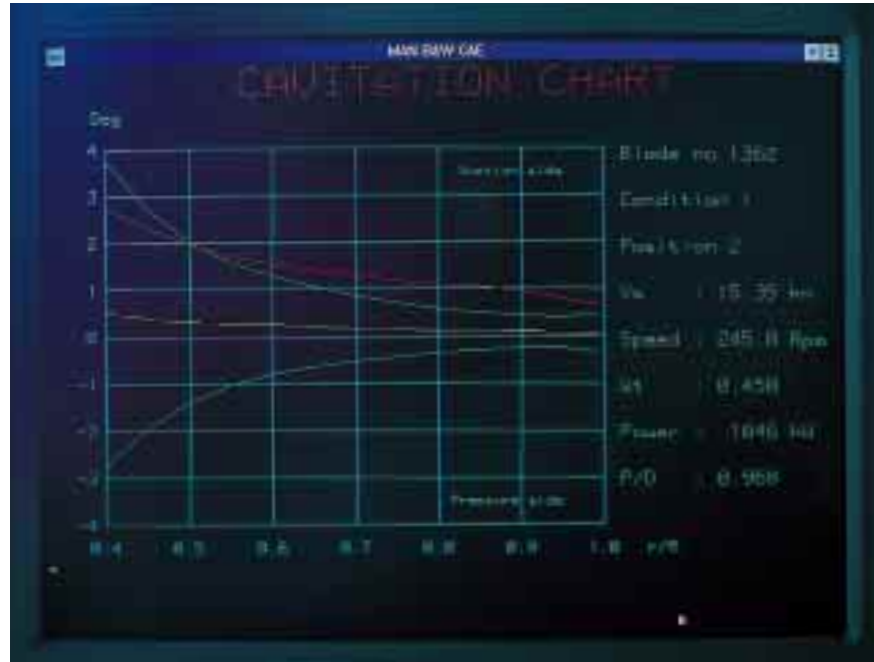

Sheet cavitation inception curves.

One disadvantage of the lifting line model lies in the nature of the method. The substitution of the blade with a lifting line implies that the chord-wise extension of the lift is not directly included in the solution. After the appearance of the lifting surface method, a set of correction factors has been published [5,6] which can be incorporated into the lifting line model to improve the calculation accuracy.

Cavitation extension on a propeller blade.

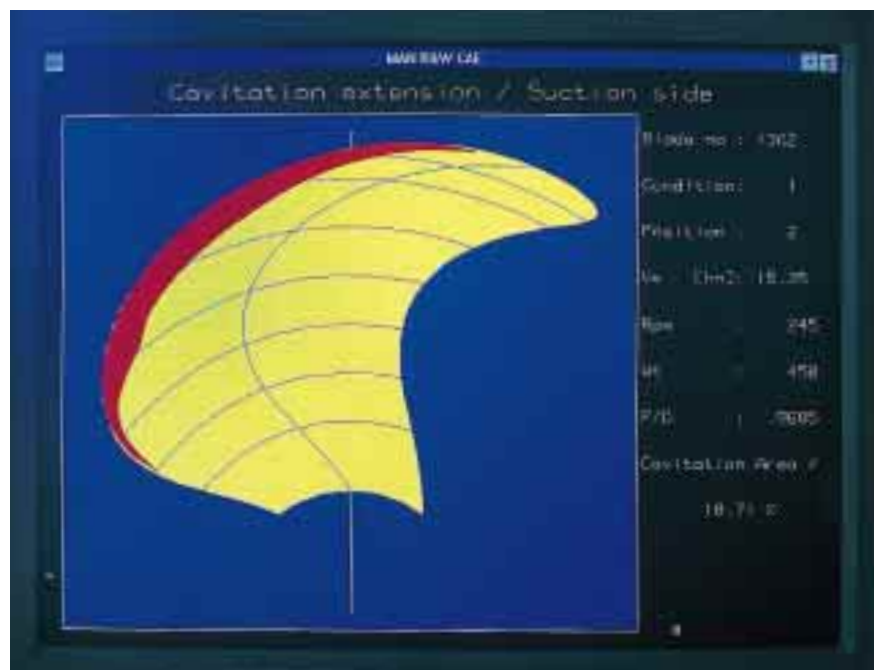

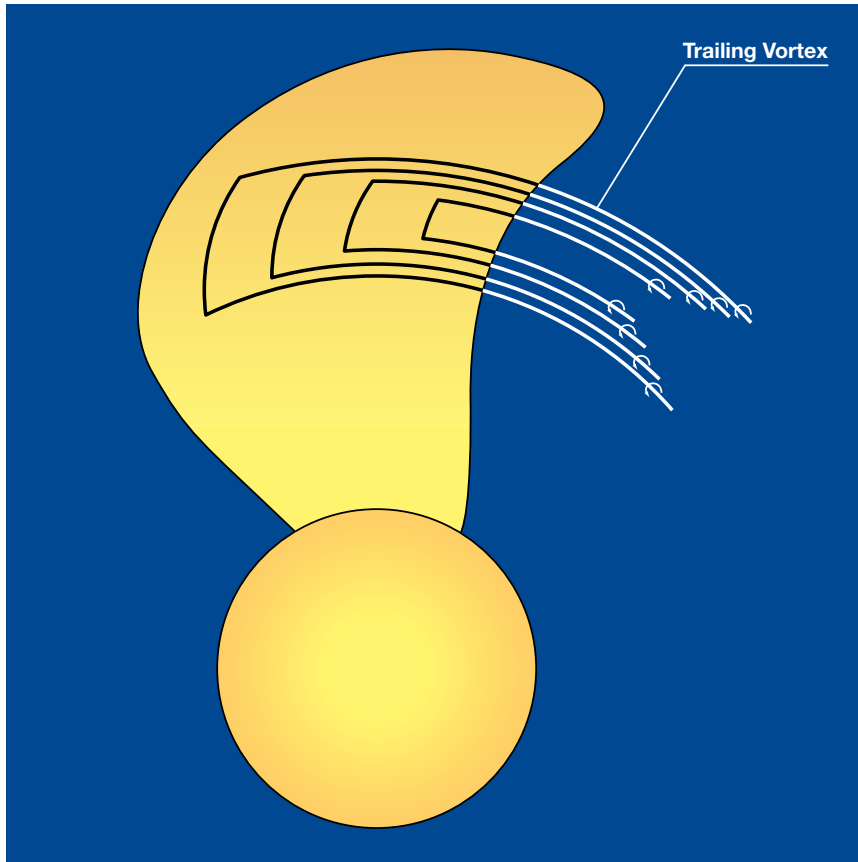

Principle of the "lifting surface" calculation model.

Lifting Surface Designed Propellers

An improvement of the lifting line model was developed in the 1980's (Greeley and Kerwin [7]) in an effort to overcome the shortcomings of the inadequate treatment of chord-wise lift of the lifting line method as well as to include the influence of skew and rake.

The method distinguishes itself from the lifting line, in the way it models the propeller blade. The surface of the blade is subdivided into a number of elements describing the surface, and on which a boundary condition of no through-flow is prescribed. To model the strength of the circulation/lift a distribution of vortices are located on the mean surface, and to include the effect of induced drag, a

number of free trailing vortices are shed from each element. The method proved valuable in contribution to the understanding of skew and in particular its influence on pitch, camber and thickness which the lifting line had failed to do, without the inclusion of lifting surface correction factors.

As with the lifting line method, the lifting surface method is sensitive as to how the trailing wake is modelled. This is especially important for heavily loaded propellers.

Surface Panel Designed Propellers

At the beginning of the 1990's, MAN B&W joined forces with two other companies (Ødegaard & Danne-skiold Samsøe and the Danish Maritime Institute) to develop a new computer program for calculating of propeller performance and to adopt the latest published technique called the Surface Panel method. The comprehensive project, which was financially supported by the Danish Ministry of Industry took 4 years and 13000 man-hours to complete. The program and the results were first published at a RINA conference in 1995 [8].

The method is unique in the sense that it does not only include the propeller blades but also other elements such as propeller hub and nozzle. Even the hull surface can be a part of the solution. Needless to say the calculation requires a fast computer work station especially equipped for this purpose.

The program is mainly developed for analysing of propellers and not as a daily design tool for new propeller blades. But the program has already given a deeper insight into a number of new areas such as hub and blade interference and novel propeller blade designs such as tip-fins.

Calculation of cavitation and its extension is a part of the program. The inclusion of the hull surface above the propeller enables the program to determine the forces in the aft ship originating from the cavitating propeller. The results can form the basis for a subsequent Finite Element calculation of the complete hull to disclose if any undesirable resonance or vibration exist.

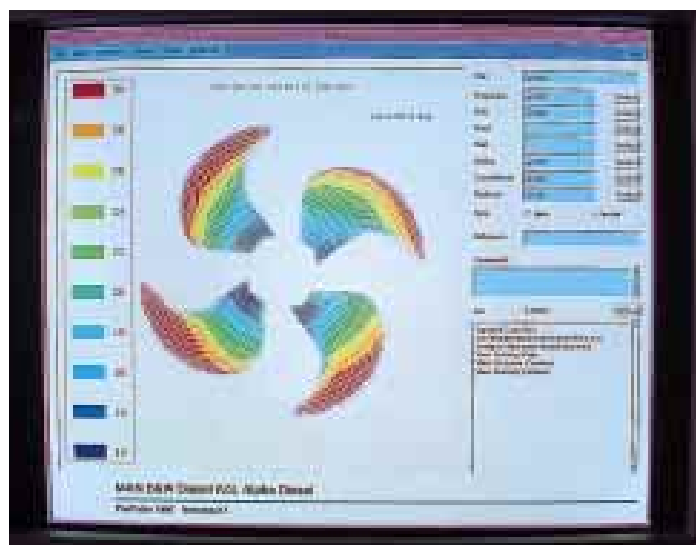
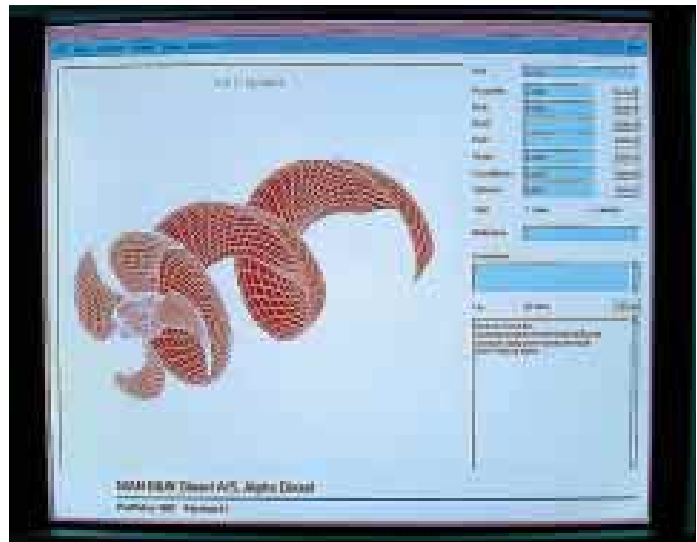
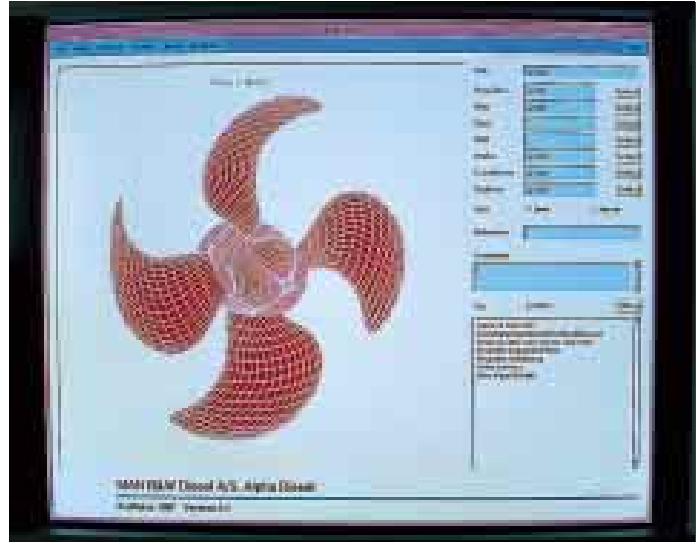

The "surface panel" method for:
 Panellised propeller hub and blades (upper)
 Panellised trailing wake (middle)
 Chordwise velocity distribution (lower)

Hydrodynamic Design of CP Propellers

In the past it was said that designing of propellers is partly a science, partly an art. This statement is still valid today although the tools described previously provide a valuable help. But one has to keep in mind that not only does the propeller form part of the propulsion system, it also interacts with the hull.

Design Conditions

Prior to entering into the actual design phase, knowledge should be acquired of the operating conditions of the vessel as well as of the propulsion engine.

The first step is to agree with the customer on the conditions for which the propeller should be optimised. The following cases outline a number of possibilities:

1 The propeller is to be optimised for 85% engine load with a 15% sea margin at a draft of 8.5m. Propeller revolutions will be determined according to the combinator curve.

In this case the ship's speed will be determined during the design phase and based on tank test results including the 15% sea margin, or if not available from a ship's speed prognosis calculated by MAN B&W. The revolutions will be derived from the actual combinator curve.

2 The propeller is to be optimised for a ship's speed of 14 knots while operating at a draft of 8.5m and including a sea margin of 15%. Propeller revolutions will be determined according to the combinator curve. This case is identical to the above except that the engine load will be calculated, instead of the ship's speed.

3 The propeller is to be optimised

for 90% engine load including a service load on the shaft generator of 450 kW with a 15% sea margin at a draft of 8.5m. The fixed propeller revolutions to be determined from the synchronous speed (corresponding to 50 or 60 Hz) of the step-up gear for the shaft generator.

As in the first case the ship's speed will be determined during the design phase, but since the vessel is equipped with a shaft generator, the power available for propulsion will be reduced with the shaft generated power. It should be noted that it is the anticipated service load of the shaft generator, which is used and not the rated power of same.

Due to the requirement of keeping a constant frequency, a constant shaft and propeller speed must be observed and manoeuvring is accomplished solely by changing the pitch - unless a frequency converter is foreseen. The propeller revolutions are determined from the requirement of keeping the said frequency of 50 or 60 Hz and the gear ratio in the step-up gear for the shaft generator. This revolution is usually 2-5% lower than the one corresponding to the MCR revolution of the main engine.

The three different examples of how to optimise a propeller and its way of operation are illustrated in the Propeller operating diagram below.

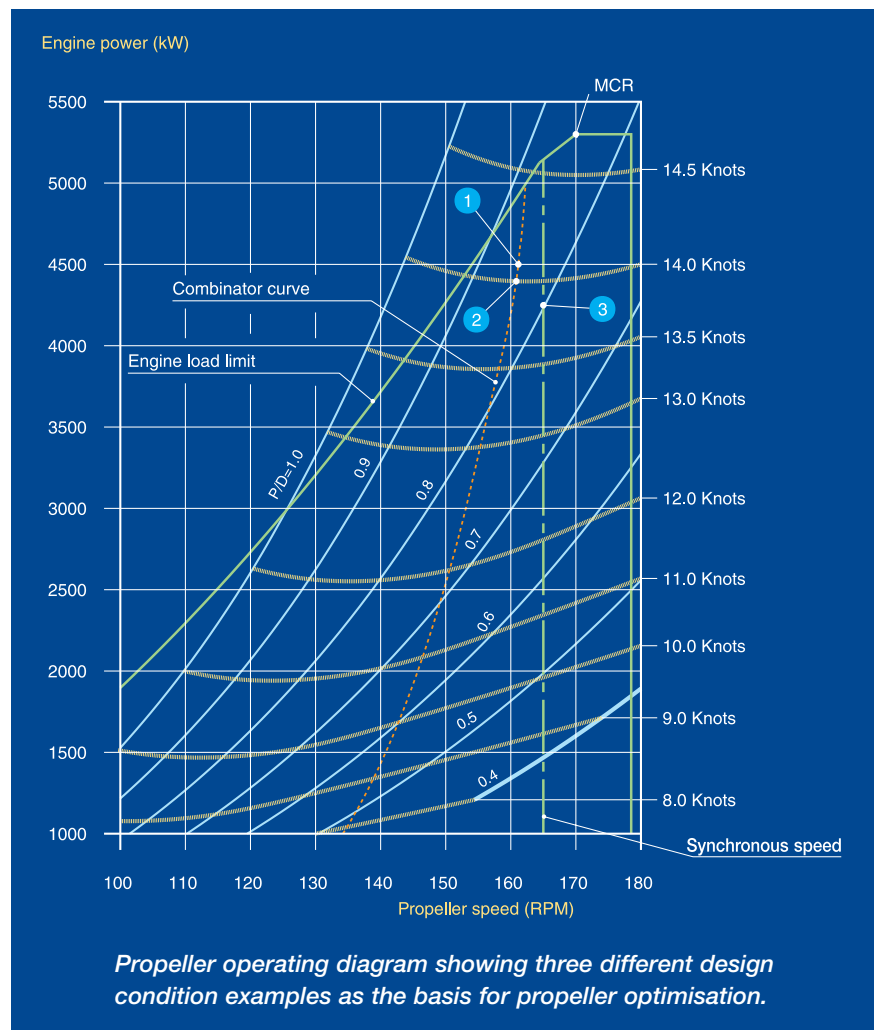

It is of vital importance that the optimisation conditions are fully understood and agreed upon with the customer before starting the design process.

Besides the optimisation conditions the propeller must be designed and dimensioned for sufficient strength at the maximum power (MCR) condition according to the rules & regulations of the actual classification society. Other conditions such as trial (lower draft and no sea margin) and off design (ie prolonged operation at low pitch settings at max revolutions) may be included.

Main Parameters

An important part of the optimisation is to determine the main parameters - propeller diameter and rate of revolution - to match each other based on the optimisation condition agreed upon.

At first this is done in a project stage as a part of the MAN B&W project service and thus forms the basis for a quotation. After the order has been placed, it often pays off to make a fine tuning of the final propeller diameter if the revolution is fixed (in the case of direct driven low-speed two-stroke plants) or the gear ratio (in the case of medium-speed geared four-stroke plants).

This optimisation should be based on the result from the model tests and includes an evaluation of the cavitation induced noise and vibration to the hull.



Measured wake field in model scale.



Full scale wake field calculated from model wake field.

Tank Test Results

The test performed by one of the tank test institutions forms an important basis for the design of the propeller. It is commonly believed that the propeller designer only needs the wake field measurements to conclude the design, but to ensure that an optimum design is reached, a complete set of reports should be forwarded. At MAN B&W, the reports are used to analyse the wake field to compensate for the difference in propeller diameter and skew distribution as well as scaling from model to full scale. In the “resistance part” of the reports, the resistance is modified in order to account for the sea margin, and from the “self propulsion part” of the reports the propulsion factors (wake fraction, thrust deduction and relative rotative efficiency) are used to arrive at the correct thrust for a given ship’s speed.

Design Objectives

Once the optimisation condition and tank test results have been analysed, the actual design of the propeller blade can proceed.

To achieve the optimum solution, a design should evolve that has the highest possible efficiency and at the same time maintains low noise and vibration characteristics.

Propellers are traditionally judged by their open water efficiency without paying attention as to how they perform behind a hull.

Restricting oneself to select a propeller from the open water efficiency alone could lead to false conclusions.

To fulfil the design objective of having the highest possible efficiency, it is necessary to introduce the concept of Total Propulsion Efficiency (TPE) which constitutes the following part efficiencies:

- Open water efficiency (η_o)
The efficiency of the propeller when operating in open water without the obstructing flow from the hull.
- Hull efficiency (η_h)
A fictitious efficiency - can exceed 1 - and is a measure of how well the hull and propeller perform in combination.
- Relative rotative efficiency (η_r)
A fictitious change in efficiency - can exceed 1 - showing how well the propeller is operating in the “behind the hull condition” compared to the “open water condition”.
- Mechanical efficiency (η_m)
The efficiency of converting mechanical power measured at the flywheel of the main engine to the propeller.

The Total Propulsion Efficiency is the product of the above part efficiencies and is defined as

$$TPE = \eta_o \times \eta_h \times \eta_r \times \eta_m$$

Compared to the more well-known QPC (Quasi Propulsive Coefficient) which does not contain the mechanical efficiency, The Total Propulsion Efficiency (TPE) forms a more consistent and stringent way of evaluating different propulsion systems.

The advantage of using the TPE compared to the QPC is its direct correlation with the power and fuel consumption needed for propulsion.

At MAN B&W the following mechanical efficiency figures are used:

Two-stroke propulsion plants without reduction gearbox	99 %
Four-stroke propulsion plants with reduction gearbox	97 %
Geared diesel electric propulsion plants	89.5 %

The low efficiency of diesel electric propulsion plants is remarkable but the figure is composed of the following efficiency elements:

GenSet efficiency	96 %
Transformer and converter	98 %
Electric motor for propulsion	98 %
Reduction gear from electric motor to propeller shaft	98 %
Shaft line and losses in bearings	99 %

Blade Design

With all preconditions set the blade design can proceed.

The main objectives within the constraint mentioned earlier is to obtain as high a TPE as possible and to suppress the cavitation to an acceptable level. However, for a fixed propeller diameter the only part-efficiencies being influenced by the blade design are the open water efficiency

and the relative rotative efficiency. It is a common belief among propeller designers that the two design objectives are in contradiction to each other and consequently must be balanced to get a compromised design.

But today some design features are available which can be applied to reduce the cavitation without sacrificing the efficiency.

To build up a propeller blade, the complicated 3-dimensional form is usually reduced into 2-dimensional elements which are then adjusted during the design process.

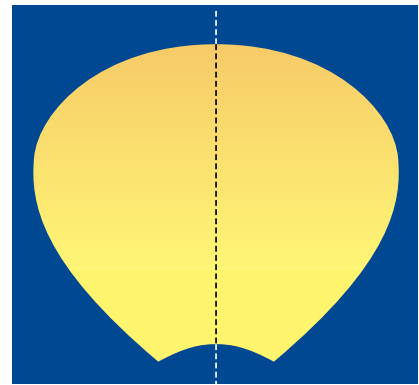
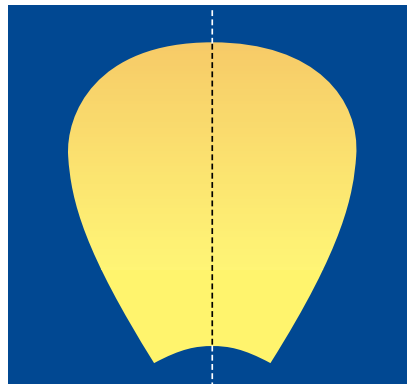
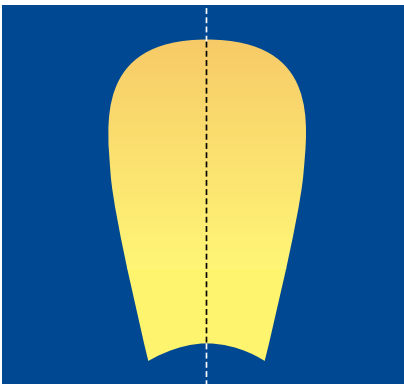

• Blade area

The blade area should be kept as small as possible in order to reduce the friction losses when turning in the water, but to suppress the cavitation extension a certain area is needed. A measure of the blade area is the so-called “blade area ratio” (A_e/A_o) which is the ratio of all the blades compared to the area of the circle circumscribed by the propeller diameter.

Different blade area ratios:

Left: $A_e/A_o=0.40$

Center: $A_e/A_o=0.55$

Right: $A_e/A_o=0.70$

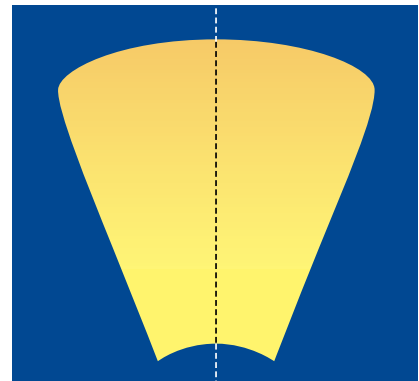
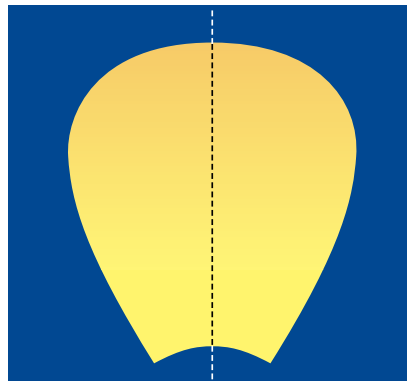
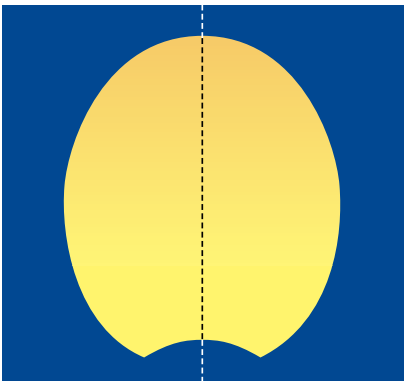

• Blade shape

The blade shape can be varied to even out the cavitation along radius and in the case of a nozzle propeller, it is advantageous to have wide-chord length at the tip (Kaplan shape).

Different blade shapes.

Max chord location varied from center of blade to tip of blade.

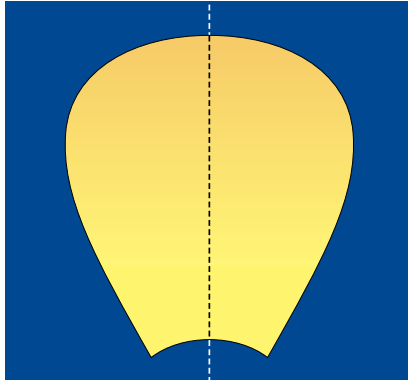

Non skew.

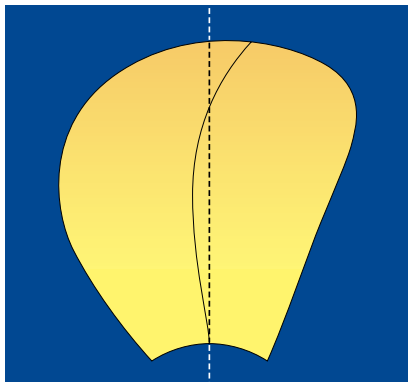

Low skew.

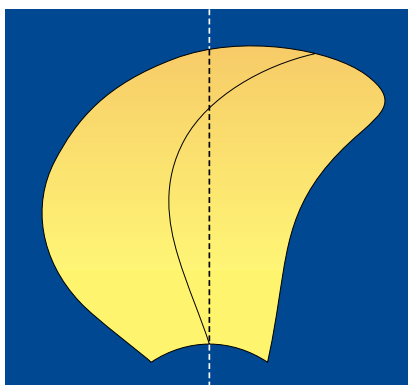

Medium skew.

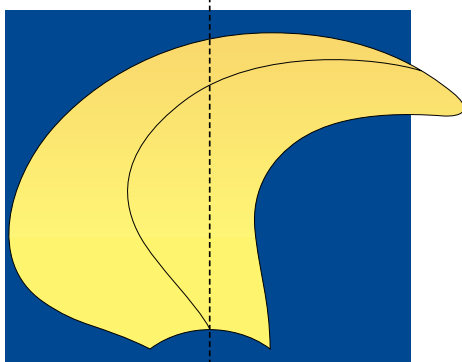

• **Skew angle**

A powerful tool to suppress propeller induced noise and vibration is the application of skew. For modern CP propellers, the skew distribution is of the balanced type, which means that the blade chords at the inner radii are skewed (moved) forward, while at the outer radii the chords are skewed aft. By applying this type of skew it is possible to control the forces (spindle torque) needed for pitch settings. In most cases the blades will be balanced in such a way that the forces in the design pitch setting will be zero.

Skew has the advantage of reducing the pressure impulses emitted from propeller to the hull surface to as much as one third of an unskewed design without sacrificing the efficiency, which will remain unchanged.

• **Rake**

The noise and vibration level in the aft ship depends on the distance between the propeller tip and hull surface - in particular exactly above and in front of the propeller.

A way of increasing the distance is to rake (incline) the blade towards aft. As with skew the efficiency remains unchanged. However, the blade is exposed to higher stresses originating from an increase in the centrifugal forces which must be counteracted by an increase in blade thickness.

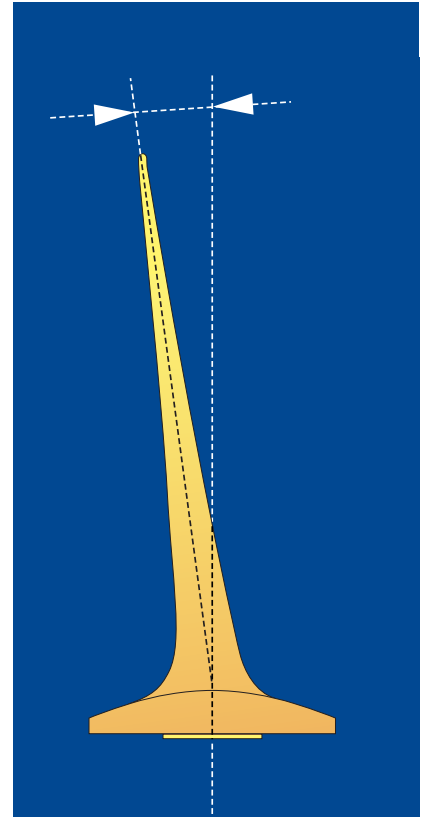

Aft raked propeller.

High skew.

• **Profile section**

For each radius, the blade is built-up of 2-dimensional airfoil sections. The airfoil used in propellers is mostly from the NACA family series which have proven successful in having both low drag and good cavitation characteristics.

A NACA profile is characterised by a basic thickness and a camber distribution which can be changed independently of each other. This facilitates the design of profiles with specific properties at each radius.

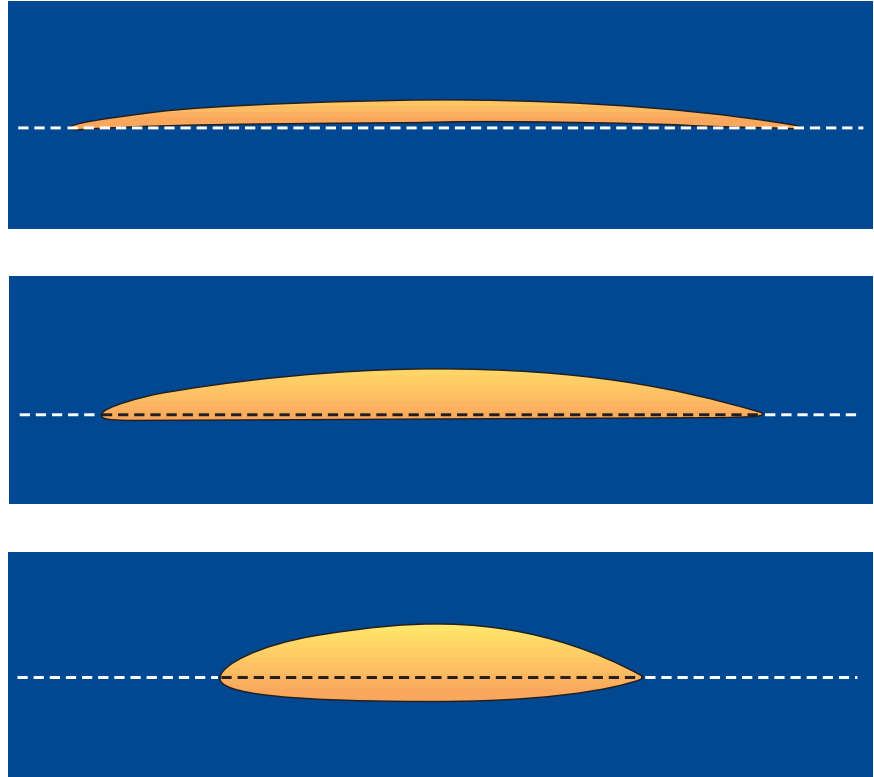

Typical profile sections at different propeller radii.

In addition to the profiles own 2-dimensional thickness and camber distribution, their distribution along the radius is also varied to achieve an optimum thrust distribution.

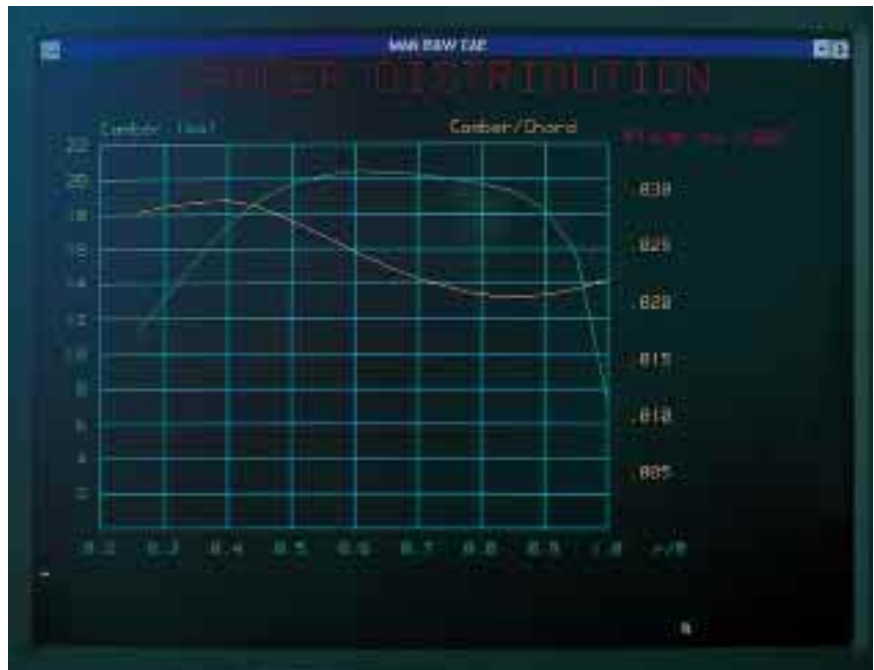

Radial camber distribution.

- **Pitch distribution**

An important parameter in propeller design is the distribution of pitch as a function of radius which need not be constant as is the case with a screw or bolt thread as the propeller is moving its way through water. Using pitch reduction at both the hub and the tip can be advantageous in reducing the cavitation extension, although care must be taken not to apply excessive reductions which will result in a decrease in efficiency.

The optimum propeller combines all the parameters mentioned into a design, which apart from the two main hydrodynamic objectives, also will fulfil the requirements of sufficient mechanical strength, low pitch changing forces, sufficient space between blades to allow pitch from full ahead to full astern, etc.

All the parameters mentioned depend on each other and no theory exists on how to combine them to an optimum design. Consequently, it is important that a software package is at hand to allow calculation of the influence of all factors. A highly educated staff with many years of experience combined with in-house developed software makes MAN B&W enjoy a leading position in propeller design and manufacturing for merchant ships.

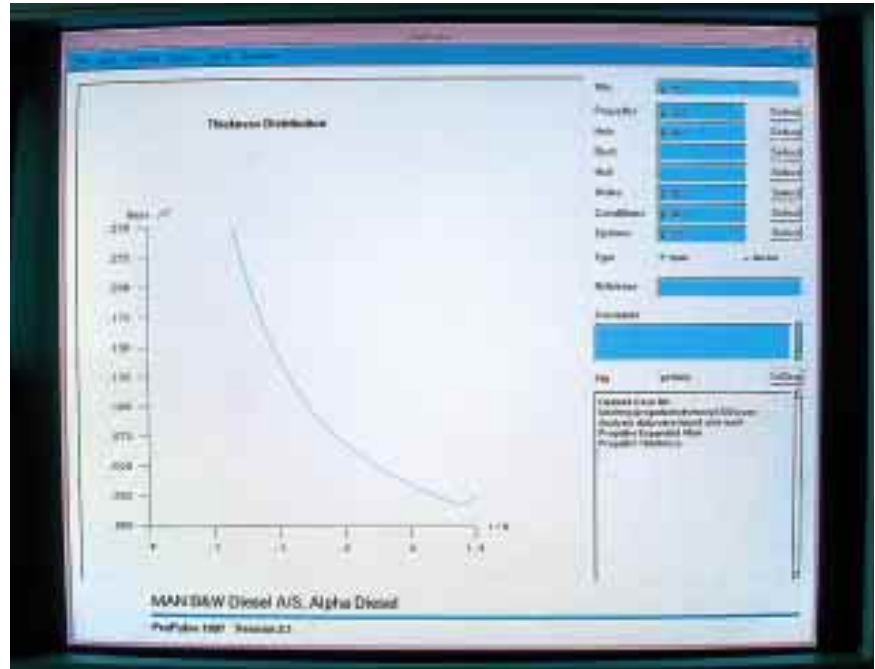

Radial thickness distribution.



Radial pitch distribution.

Model Test and Full Scale Results

Through the years MAN B&W has carried out a large number of tests with propellers of their own design at most of the independent tank institutions around the world.

Apart from verifying the calculations, the tests play an important role in assuring the ship owner, consultant and shipyard that the propeller performance is acceptable. As the tests usually are carried out before the ship is built, all partners in the project have the possibility of modifying not only the propeller design but also the hull form before the actual manufacturing is started.

In contradiction to full scale tests, model tests have the advantage that they can be conducted under the same conditions, thereby excluding the influence of sea, wind and hull surface condition. The results obtained for different designs or modifications to either the propeller or hull are thus readily comparable. This is especially true with regard to power and efficiency evaluation.

The hull vibrations originating from propeller induced pressure impulses can be verified from both model tests and full scale measurements.

Cases

To exemplify the level of performance increase that can be expected from a well-designed propeller, the following cases are given.

All figures are as measured by the hydrodynamic institution mentioned.



Model test of a high skew propeller for a twin screw 3990 GT cruise vessel.

Twin Screw 3990 GT Cruise Vessel

The vessel has a MAN B&W four-stroke medium-speed propulsion plant developing 1960 kW per shaft for a ship's speed of 17.8 knots. Tests carried out by Marin Wageningen, The Netherlands.

Main propeller parameters

Propeller diameter	mm	2850
Blade area ratio	-	0.55
Skew angle	deg	45

Measured performance

Propeller open		
water efficiency	%	70.2
Pressure impulses	kPa	0.9

The efficiency (TPE) turned out to be 2.8% higher than for the stock propeller selected by the tank institution. The pressure impulse level was evaluated as very low even based on the high demands required by a cruise ship.

In reference [9] the performance obtained during testing and sea trial is presented by the consultant.

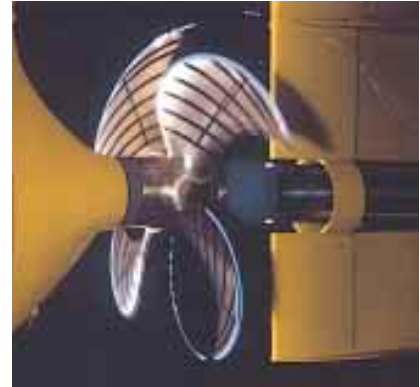

Model test of a high skew propeller for a single screw 6000 DWT chemical tanker.

Single Screw 6000 DWT Chemical Tanker

The vessel is powered by a MAN B&W low-speed two-stroke propulsion plant developing 3600 kW for a ship's speed of 14.0 knots.

Test carried out by Marintek, Norway.

Main propeller parameters

Propeller diameter	mm	4100
Blade area ratio	-	0.52
Skew angle	deg	35

Measured performance

Propeller open		
water efficiency	%	59.8
Pressure impulses	kPa	1.4

The efficiency (TPE) turned out to be 6.7% higher than for the stock propeller selected by the tank institution. The high gain in efficiency compared to the stock propeller was obtained through a slight decrease of the propeller diameter. Even though in theory the open water efficiency would suffer, this was more than counteracted by a substantial increase in hull and rotative efficiency - indicating that the propeller is well adapted to the hull.

The pressure impulse levels were very low for this type of ship and can partly be ascribed to a large propeller/hull clearance.



Model test of a high skew propeller for a single screw 16000 DWT tanker.

Single Screw 16000 DWT Tanker

The vessel is powered by a MAN B&W four-stroke medium-speed propulsion plant developing 4800 kW for a ship's speed of 15.3 knots. Tests carried out by Marintek, Norway.

Main propeller parameters

Propeller diameter	mm	5400
Blade area ratio		0.48
Skew angle	deg	45

Measured performance

Propeller open water efficiency	%	64.4
Pressure impulses	kPa	1.6

The efficiency (TPE) turned out to be 3.4 % higher than for the stock propeller selected by the tank institution. The gain in efficiency compared to the stock propeller was obtained by a pronounced increase in the open water efficiency.

The pressure impulse level is considered low for this type of ship and is partly due to a large propeller/hull clearance.



Model test of a high skew propeller for a single screw 5100 DWT chemical tanker.

Single Screw 5100 DWT Chemical Tanker

The vessel is powered by a MAN B&W low-speed two-stroke propulsion plant developing 4200 kW for a ship speed of 14.2 knots.

Test carried out by the Danish Maritime Institute, Denmark.

Main propeller parameters

Propeller diameter	mm	4050
Blade area ratio	-	0.52
Skew angle	deg	45

Measured performance

Propeller open water efficiency	%	60.9
Pressure impulses	kPa	0.7

The efficiency (TPE) turned out to be 4.3% higher than for the stock propeller selected by the tank institution. The gain in efficiency compared to the stock propeller was mainly obtained by an increase in the open water efficiency.

The pressure impulses were very low for this type of vessel.



Twin Screw Supply Vessel AHTS

The vessel is powered by a four-stroke medium-speed propulsion plant developing 2400 kW per shaft for a ship's speed of 14.5 knots. Test carried out by the Danish Maritime Institute, Denmark.

Main propeller parameters

Propeller diameter	mm	3150
		in nozzle
Blade area ratio	-	0.55
Skew angle	deg	5

Measured performance

Propeller open		
water efficiency	%	59.6
Bollard pull	ton	87.0

The main design objective for at supply vessel is a high bollard pull while still maintaining a satisfactory free sailing efficiency. In this particular case the bollard pull turned out to be 3.6% higher than for the stock propeller.

Model test of a ducted propeller for a twin screw AHTS vessel.



The AHTS model propeller.

Conclusion

The propeller is an important part of the propulsion plant.

The propeller must be carefully designed in conjunction with each specific vessel in order to obtain not only a high efficiency but also a high level of comfort.

It has been demonstrated that a substantial increase in efficiency can be attained by a careful design of the propeller without sacrificing the noise and vibration level or other operational parameters.

Independent of the type of ship, a higher propeller efficiency can be translated into a proportional decrease in fuel consumption which over the lifetime of the ship can accumulate a substantial saving.

The knowledge of complete propulsion plant technology possessed by MAN B&W ensures the customer that the propeller is designed in an optimum manner with due regard to all parts of the propulsion plant, ship's hull and operating profile.

References

- [1] Kuiper, G 1992. The Wageningen Propeller Series. Marin publication 92-001.
- [2] Lerbs, H W 1952. Moderately loaded propellers with a finite number of blades and an arbitrary distribution of circulation. SNAME Transaction 60: 73-117.
- [3] Brockett, T 1966. Minimum pressure envelopes for modified NACA-66 sections with NACA $a=0.8$ camber and Buships type I and type II sections. David Taylor Model Basin report 1780.
- [4] Nielsen, J R, RELIFT program documentation. MAN B&W internal document, 1992.
- [5] Morgan, W B, Silovic, V, Denny, S. B. 1968. Propeller lifting-surface corrections. SNAME Transaction 76: 307-347.
- [6] Cumming, R A, Morgan, W B, Boswell, R J 1972. Highly skewed propellers. SNAME Transaction vol. 80.
- [7] Greeley, D S, Kerwin, J E 1982. Numerical methods for propeller design and analysis in steady flow. SNAME Transaction 90: 415-453.
- [8] Rasmussen, U M, Weis-Fogh, K. 1995. Numerical analysis of marine propellers for noise & vibration control purposes. RINA international conference on noise & vibration in the marine environment.
- [9] Kanerva, M 1991. Luxury yacht ships of Finish design. Cruise Business 1991: 48-49